

# NOTICE

**Note that when converting this document from its original format to a .pdf file, some minor font and format changes may occur. When viewing and printing this document, we cannot guarantee that your specific PC or printer will support all of the fonts or graphics. Therefore, when you view the document, fonts may be substituted and your individual printer may not have the capability to print the document correctly.**





**NEC**

INT-2078 (UNIV)  
ISSUE 1.0

***UNIVERGE SV8100  
DT310/DT330/DT710/DT730***

---

**USER GUIDE**

**NEC Infrontia Corporation  
July, 2008**



## **LIABILITY DISCLAIMER**

NEC Unified Solutions, Inc. reserves the right to change the specifications, functions, or features, at any time, without notice.

NEC Unified Solutions, Inc. has prepared this document for use by its employees and customers. The information contained herein is the property of Unified Solutions, Inc. and shall not be reproduced without prior written approval from NEC Unified Solutions, Inc. All brand names and product names on this document are trademarks or registered trademarks of their respective companies.

Copyright 2008

NEC Unified Solutions, Inc.



# TABLE OF CONTENTS

---

## 1. INTRODUCTION

General .....	1
Face Layout .....	2
Keys And Parts .....	5
Icon Display .....	15
Menu List .....	16
Simple Operation by Menu Key and Cursor Key .....	16

## 2. TERMINAL SETUP

Terminal Setup With the Up/Down Key .....	17
Terminal Setup With the Feature Key .....	18

## 3. BASIC OPERATION

Login (DT700 Series Only) .....	21
Logout (DT700 Series Only) .....	21
To Start Security Mode (DT730 Only) .....	22
To Cancel Security Mode .....	22

## 4. FEATURE OPERATION

ANSWERING CALLS .....	23
PLACING CALLS .....	24
MICROPHONE CONTROL .....	27
SPEAKERPHONE CALLS .....	27
GROUP LISTEN .....	27
HOLDING CALLS .....	28
TRANSFERRING CALLS .....	28
CONFERENCE .....	29

## TABLE OF CONTENTS

---

CALL PARK – SYSTEM .....	29
STATION BUSY/NO ANSWER OPTIONS .....	30
CO/PBX DIALING OPTIONS.....	33
CALL PICKUP .....	36
PAGING.....	37
BACKGROUND MUSIC .....	39
CALL FORWARDING.....	39
SELECTABLE DISPLAY MESSAGING.....	41
STATION RELOCATION.....	42
CODE RESTRICTION, DIAL BLOCK.....	42
ACCOUNT CODE ENTRY .....	43
AUTOMATIC CALL DISTRIBUTION (ACD) .....	44
<b>5.DIRECTORY OPERATION</b>	
Add New Data.....	54
Find Registered Data.....	55
Make a Call From Directory .....	57
Delete All Directory Data .....	57
Delete Specific Directory Data.....	58
<b>6.CALL HISTORY OPERATION</b>	
View Call History.....	60
Make a Call From Call History .....	61
Store Call History Data to Speed Dial.....	61
Delete Call History Data .....	62



# 1. INTRODUCTION

---

## General

This guide explains how to operate DT Series (DT310/DT710/DT330/DT730) under the following headings.

### CHAPTER 1 INTRODUCTION

Explains the configuration of this guide and contains the following information.

- Face layout of DT Series
- Keys and Parts of DT Series
- Icon Display
- Menu List

### CHAPTER 2 TERMINAL SETUP

Explains the operating procedures for terminal settings of the DT Series.

### CHAPTER 3 BASIC OPERATION

Explains the basic operation of DT Series.

### CHAPTER 4 FEATURE OPERATION

Explains operating procedures for various Telephony Server features.

### CHAPTER 5 DIRECTORY OPERATION

Explains operating procedures for Directory function.

### CHAPTER 6 CALL HISTORY OPERATION

Explains operating procedures for Call History.



*DT330/DT730*

## Face Layout

**DT310/DT710 (2-button without LCD)**

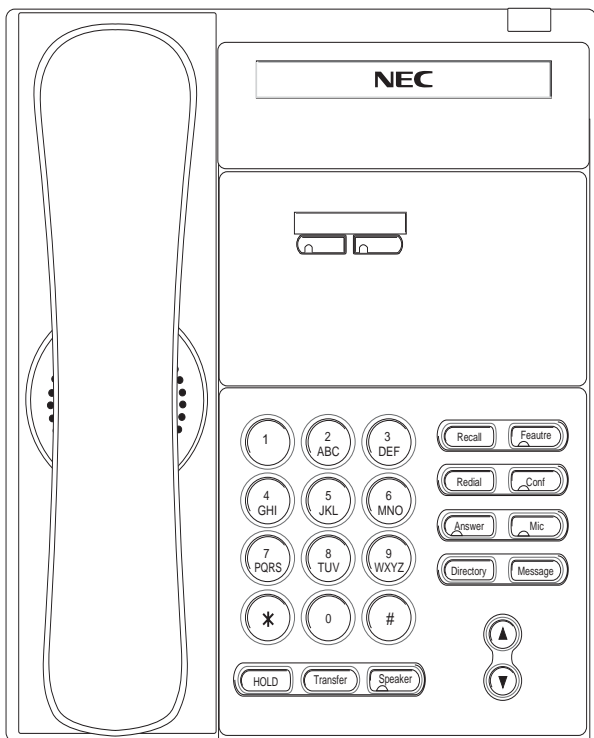

**DT310/DT710 (6-Button with LCD)**

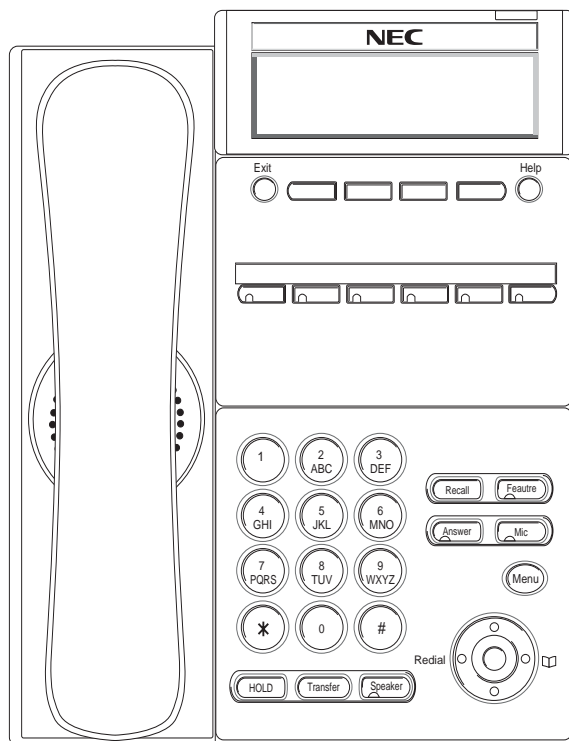

**DT710 Model shown above**

## DT330/DT730 (12-Button with LCD)

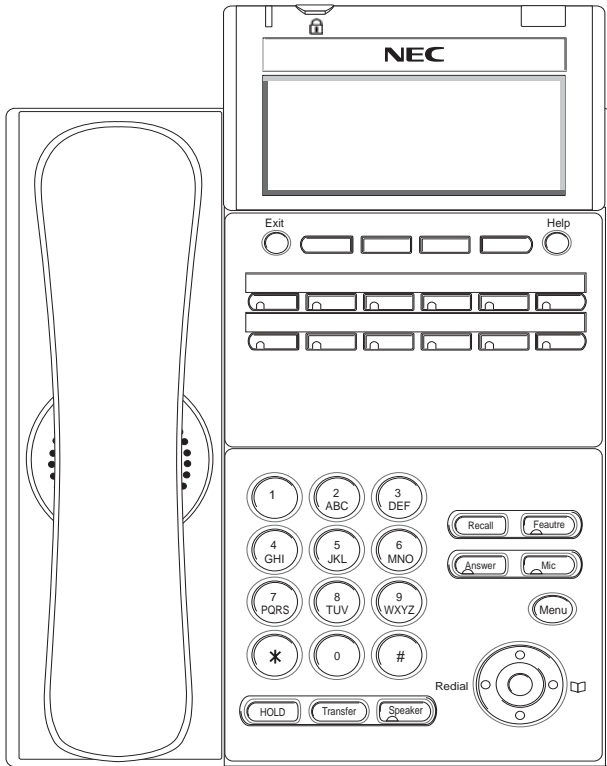

**Note:** Lock button is equipped on DT730 only.

## DT330/DT730 (24-Button with LCD)

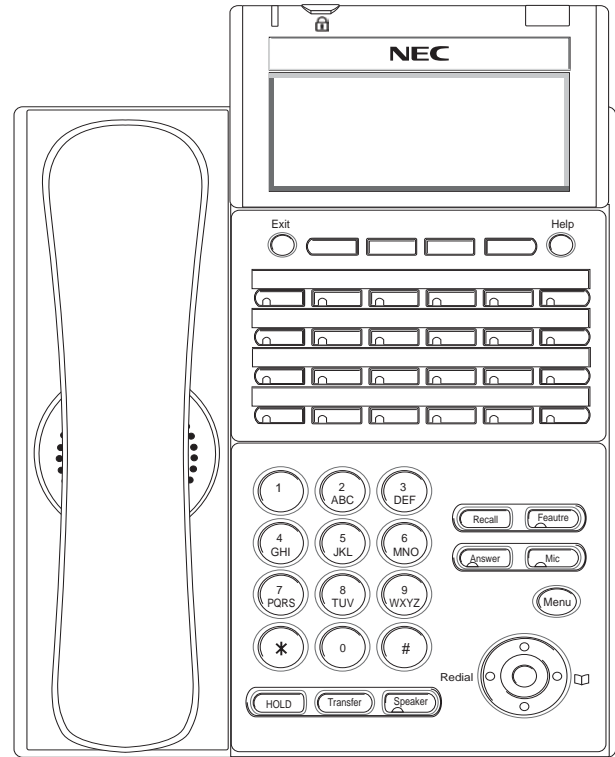

**Note:** Lock button is equipped on DT730 only.

### DT330/DT730 (32-Button with LCD)

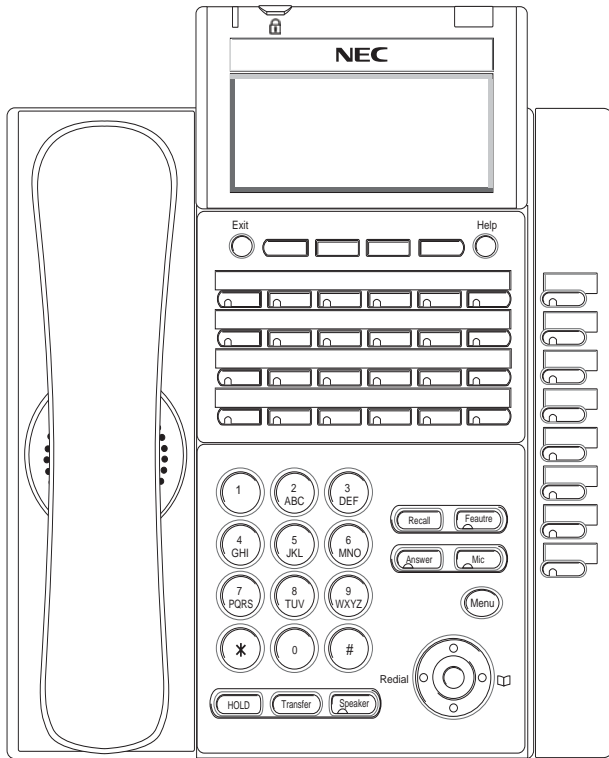

**Note:** Lock button is equipped on DT730 only.

### DT330/DT730 (DESI Less 8-Button)

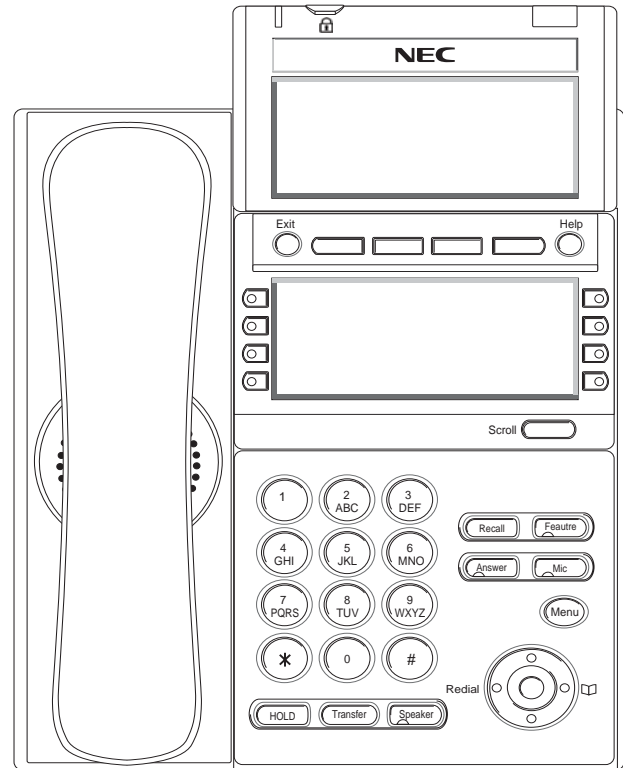

**Note:** Lock button is equipped on DT730 only.

## Keys And Parts

### DT310/DT710 (2-Button without LCD)

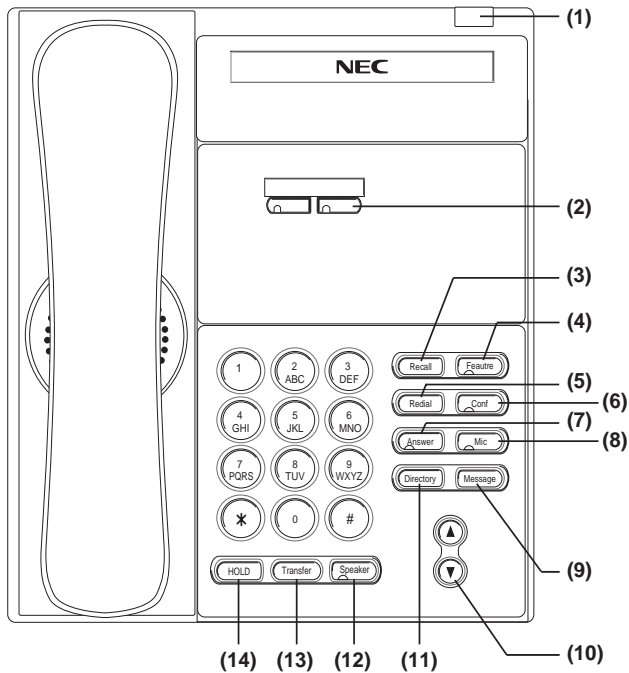

#### (1) Call Indicator Lamp

Lamp at top corner of DT Series Display flashes when a call terminates to the terminal. On the SV8100, this lamp flashes fast when a call terminates to the terminal and flashes slower when a message has been left.

#### (2) Programmable Keys

These keys can be programmed as Flexible Line key/Programmable Feature Key by Web/PCPro.

#### (3) Recall

Press key to finish an outside call and hear the dial tone.

#### (4) Feature

Used to activate any features as terminal setup functions.

#### (5) Redial

(Last Number Call, Speed Calling-Station/Group)  
Press key to activate redial feature. Press redial and scroll back through numbers that have been dialed.

#### (6) Conf

Press key to establish a three-way conversation.  
LED on key lights when key is active.

#### (7) Answer

When LED on this key is lit, press key to answer a waiting call.

#### (8) Mic

Press key to respond hands free. LED on this key lights to show the key is activated.

#### (9) Message

This key shows a message is waiting. Press this key to access the Voice Mail system (if programmed).

### **(10) Up/Down**

(∇ DOWN ^ UP)

Used to adjust LCD contrast, speaker/receiver volume, and ringer volume.

- LCD Contrast:

Press (∇) or (^) key while idle.

- Speaker/Receiver Volume:

Press (∇) or (^) key during conversation.

- Ringer Volume:

Press (∇) or (^) key during ringing.

### **(11) Directory**

Press key to activate speed calling - system feature.

### **(12) Speaker**

Controls the built-in speaker which can be used for Hands Free dialing/monitoring. LED on key lights when key is active.

DT310 supports half duplex handsfree. DT330 supports half/full duplex handsfree.

### **(13) Transfer**

Allows the station user to transfer established calls to another station, without attendant assistance.

### **(14) Hold**

Press this key to place an internal or external call on hold.

## DT330/DT730 (24-button with LCD)

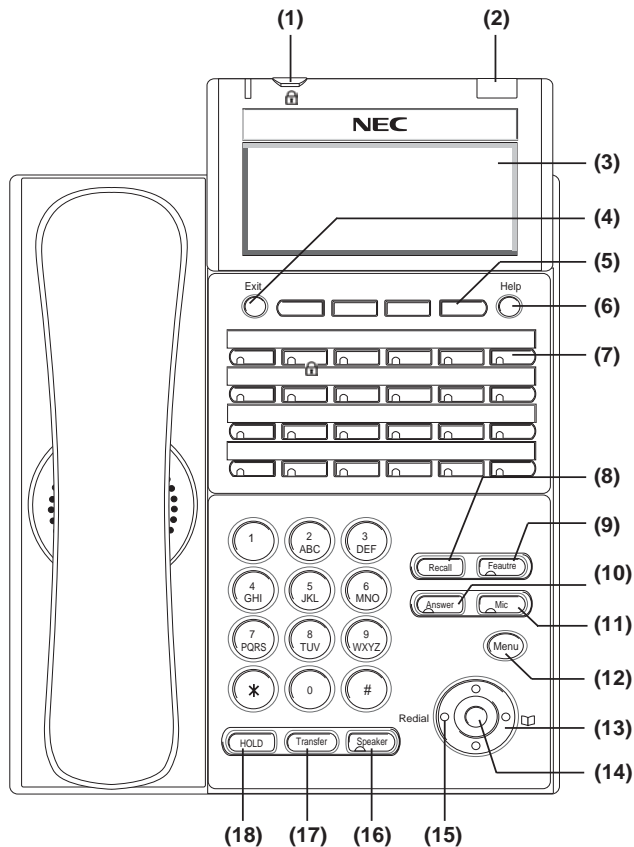

### (1) Security Button (DT730 only)

The user can prevent information leakage from terminal by simple operation.

### (2) Call Indicator Lamp

On the SV8100, this lamp flashes fast when a call terminates to the terminal and flashes slower when a message has been left.

### (3) LCD (Note 1)

LCD (Liquid Crystal Display) provides DT Series activity information plus data, time and Softkey Operation.

The LCD on DT310/DT710 has 24-character/28-character, 3-line capability.

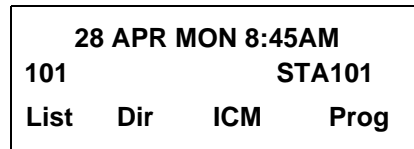

The LCD on DT330/DT730 has 28-character, 4-line capability. Top line is used exclusively for the status icons.

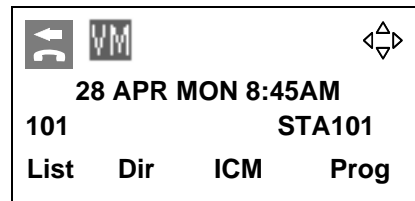

**(4) Exit**

The user can exit from a screen mode by pressing this key.

**(5) Softkeys**

Any feature shown at the bottom of the LCD is available. The appropriate feature key is displayed on the screen according to the call handling process.

**(6) Help**

The user can press this key followed by a programmable key to check what Line or Programmable Feature is programmed on the key.

**(7) Programmable Keys**

These keys can be programmed as Flexible Line key/Programmable Feature Key by the Telephony Server Administrator. For the SV8100, the programmable keys can be set by Web/PCPro and the user can also set them.

**(8) Recall**

Press key to finish an outside call and hear the dial tone.

**(9) Feature**

Used to activate any features as terminal setup functions.

**(10) Answer**

When LED on this key is lit, press key to answer a waiting call.

**(11) Mic**

Press this key to respond hands free.

**(12) Menu**

From this key, the user can access to the functions not normally used (such as terminal settings, downloads and access to XML applications) easily.

**(13) Cursor**

By using this Key, DT Series user can access various features with simple operation.

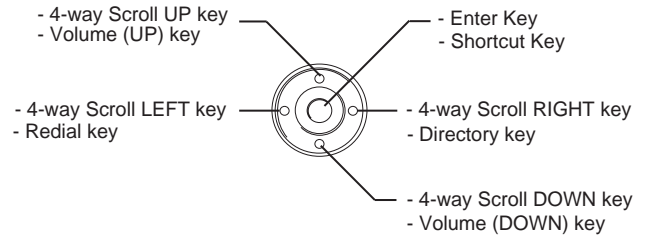

Two lines of menu items can be displayed at a time. Use "Up" or "Down" key to scroll to the item.



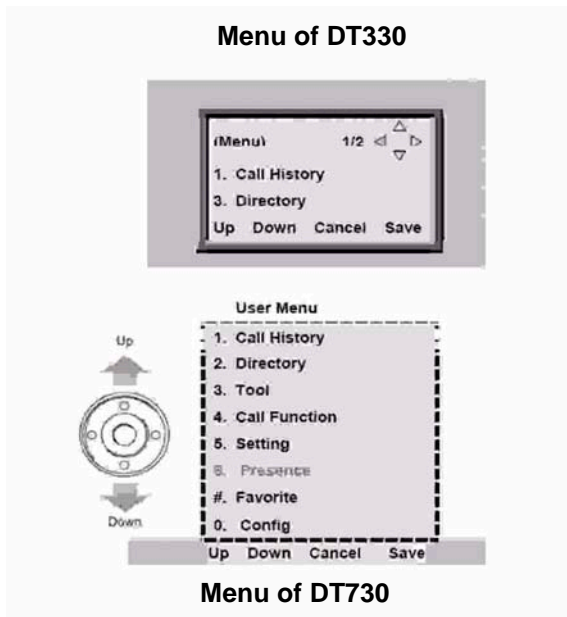

**Note:** *DT310/DT710 (2-Button without LCD) does not have the Cursor Key. DT310 (6-Button with LCD) also does not have the Cursor Key.*

**(14)Enter**

DT330/DT730 Series has Shortcut Menu for frequently-used features. The user can access to Shortcut Menu by pressing **Enter** Key.

**Note:** *DT310/DT710 Series does not support the Shortcut Menu.*

Shortcut Menu includes the following features.

Feature	Description
1. Missed Call	Access to history of Missed Call.
2. Voice Mail	Access to history of incoming Voice Mail.

**(15)Redial**

(Last Number Call, Speed Calling-Station/Group)  
Press key to activate redial feature. Press redial and scroll back through numbers that have been dialed.

When the desired number is displayed, press the # key to activate dialing.

**(16)Speaker**

Controls the built-in speaker which can be used for Hands Free dialing/monitoring.

LED on key lights when key is active.

DT310 supports half duplex handsfree. DT330 supports half/full duplex handsfree.

**(17)Transfer**

Allows the station user to transfer established calls to another station, without attendant assistance.

**(18)Hold**

Press this key to place an internal or external call on hold.

**Note 1:** *Not equipped on DTL-2E-1/ITL-2E-1.*

## DT330/DT730 (DESI Less 8-Button with LCD)

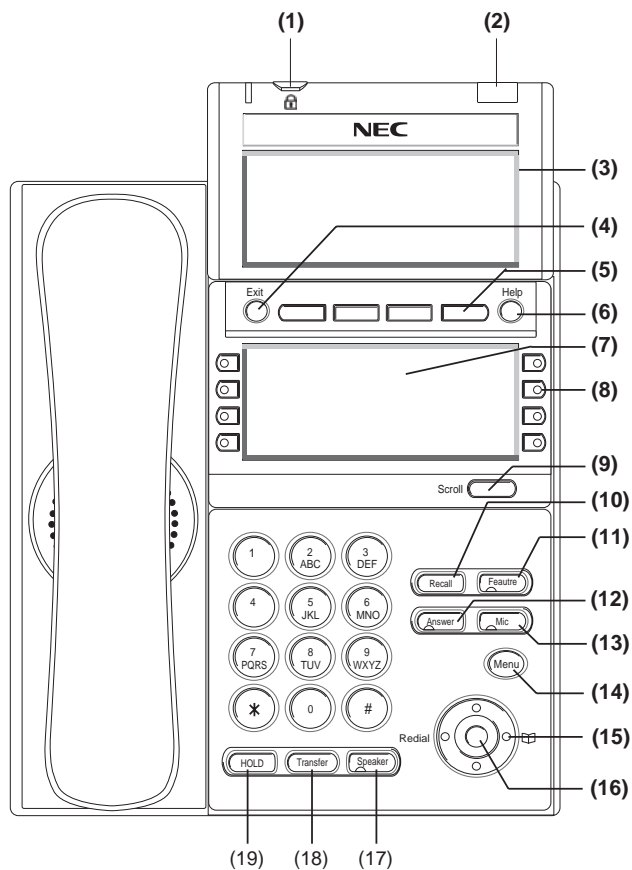

### (1) Security Button (DT730 only)

The user can prevent information leakage from terminal by simple operation.

### (2) Call Indicator Lamp

On the SV8100, this lamp flashes fast when a call terminates to the terminal and flashes slower when a message has been left.

### (3) LCD (Note 1)

LCD (Liquid Crystal Display) provides DT Series activity information plus data, time and Softkey Operation.

The LCD on DT310/DT710 has 24-character/28-character, 3-line capability.

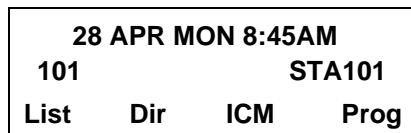

The LCD on DT330 has 28-character, 4-line capability. Top line is used exclusively for the status icons.

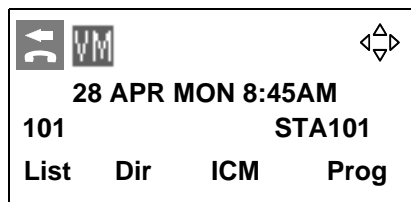

### (4) Exit

The user can exit from a screen mode by pressing this key.

### (5) Softkeys

Any feature shown at the bottom of the LCD is available. The appropriate feature key is displayed on the screen according to the call handling process.

### (6) Help

The user can press this key followed by a programmable key to Check what Line or Programmable Feature is programmed on the key.

### (7) 8LD Display

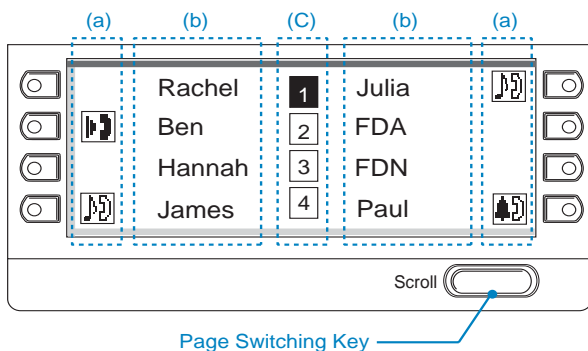

32 (8 keys x 4 pages) additional programmable keys are provided. They can be programmed as Flexible Line/Programmable feature key by Telephony Server Administrator. For the SV8100, the programmable keys can be set by Web/PCPro and the user can also set them.

**Note:** *Maximum 11 characters (including icon)*  
*Maximum 13 characters (excluding icon)*

### (a) Icon

Status of the Line key such as Call termination, Call Hold or Busy, and setting on the Feature key are shown as Icons.

User's Status	Icon	Flashing Pattern
• Idle		
• I-HOLD		Blink Note
• Others Hold		
• Recall		Blink Note
• Incoming Ringing		
• During Conversation (Individual Use)		
• Call Transfer		
• Conference		
• During Conversation (Other Party Use)		
• Active Feature (Under a setting of feature key like a "Call Forwarding")		
• Others		
• Key is busy (example, if programmed as a virtual extension and the virtual extension is busy).		Steady Lit

## (b) Feature Key Information

Feature Key Information displays the followings.

Key	Description	Maximum digits to be displayed
Line Key	- Name and Number information	Refer to note*
Feature Key	- Feature Name	Refer to note*
One-Touch Speed Dial Key	- Speed Dial Name Information - Number Information	Refer to note*

**Note:** *Maximum 11 characters (including icon)*  
*Maximum 13 characters (excluding icon)*

## (c) Page Icon

8LD display has four pages (8 Programmable Feature keys per page). Page Icon Key indicates currently displayed page. The user can switch the Feature Key display from page 1 to 4 by using the Page Switching Key.

<b>1</b>	Feature Key 1-8	Black background indicates currently displayed page.
<b>2</b>	Feature Key 9-16	
<b>3</b>	Feature Key 17-24	
<b>4</b>	Feature Key 25-32	

## (8) Programmable Keys

These keys can be programmed as Flexible Line key/Programmable Feature Key by Web/PCPro.

## (9) Scroll Key

This key is used to turn over the page of 8LD display.

## (10) Recall

Press key to finish an outside call and hear the dial tone.

## (11) Feature

Used to activate any features as terminal setup functions.

## (12) Answer

When LED on this key is lit, press key to answer a waiting call.

### (13) Mic

Press key to respond hands free. LED on this key lights showing it is active.

### (14) Menu

From this key, the user can access to the functions not normally used (such as terminal settings, downloads and access to XML applications) easily.

### (15) Cursor

By using this Key, DT Series user can access to various features with simple operation.

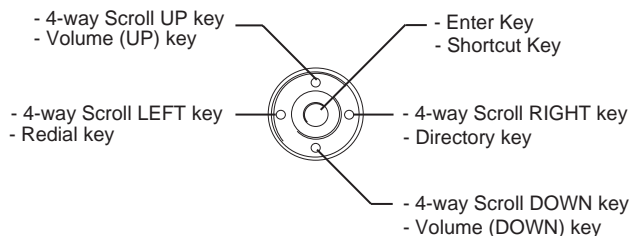

For DT330 Series, two lines of menu items can be displayed at a time. For DT730 Series, three lines of menu items can be displayed at a time. The following figure shows the menu screen for DT330 Series. Use "Up" or "Down" key to scroll to the item.

### Menu of DT330

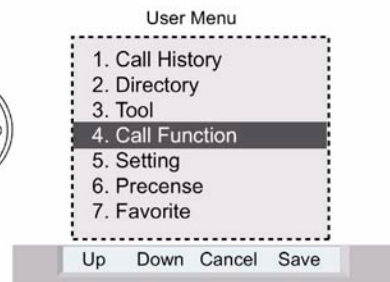

### Menu of DT730

**Note:** *DT310/DT710 (2-Button without LCD and DT310 [6-Button with LCD]) does not have the Cursor Key.*

### (16)Enter

DT330/DT730 Series has Shortcut Menu for frequently-used features. The user can access to Shortcut Menu by pressing **Enter** Key.

**Note:** *DT310/DT710 Series does not support the Shortcut Menu.*

Shortcut Menu includes the following features. (Ex. of DT730)

Feature	Description
1. Missed Call	Access to history of Missed Call.
2. Voice Mail	Access to history of incoming Voice Mail.
3. IM	Not Supported.
4. Presence	Not Supported.
5. Backlight	Access to screen for LCD backlight settings.
6. Bluetooth	Not Supported.

### **(17)Speaker**

Controls the built-in speaker which can be used for Hands Free dialing/monitoring.

LED on key lights when key is active.

DT310 supports half duplex handsfree. DT330 supports half/full duplex handsfree.

### **(18)Transfer**

Allows the station user to transfer established calls to another station, without attendant assistance.

### **(19)Hold**

Press this key to place an internal or external call on hold.

## Icon Display

The LCD of DT730 Series displays Desktop Icons which provide notification when events (such as missed call and voice mail) occur.

**Note:** *DT310/DT710 Series does not support the icon display.*

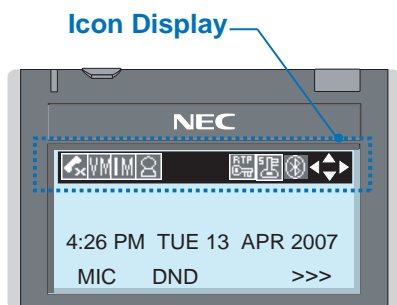

Feature	Icon	Description
Encryption <b>(Note)</b>		This icon appears when using RTP Encryption feature.
Security		This icon appears when the Security Key is pressed and the terminal in Security mode
Bluetooth		This icon appears when any peripheral equipment is connected via Bluetooth. DT330 is supported.
Cursor		This icon indicates the currently available direction of the Cursor Key.

**Note:** *Currently unavailable.*

Feature	Icon	Description
Missed Call		This icon appears when there is a missed call. Once the user has checked the missed call, this icon will disappear.
Voice Mail		This icon provides notification of incoming Voice Mail. Once the user has checked the mail, this icon will disappear.
Instant Message <b>(Note)</b>		This icon appears when the terminal receives a new instant message. Once the user has checked the message, this icon will disappear.
Presence <b>(Note)</b>		This icon indicates the terminal's presence status.

## Menu List

From the Menu List, the user can use various application features such as Directory and Call History.

### To Display Menu List

- Press  Key. The Menu List is displayed in LCD. Use Cursor Key to select desired Menu Item.

No.	Menu Item	Description
1	Call History	To view Call History.
2	Directory	To use Directory function.
3	Tool	Settings to set Ring Volume, Off Hook Ring, Backlight, Headset, and Peripherals.
4	Call Function	Currently Not Used (grayed out).
5	Setting	To set up the terminal such as ringing volume control, LCD display setting and download of Music on Hold.
6	Presence	Currently Not Used (grayed out).
#	Favorite	By registering frequently-used features as favorite, the user can access these features with simple operation.
0	Terminal Config	This item is used for Configuration setting of DT Series.

**Note:** Operation for Instant Message (IM) is currently unavailable.

**Note 1:** Unavailable Menu items are grayed out.

## Simple Operation by Menu Key and Cursor Key

By using Menu Key and Cursor Key, DT Series user can have access to Call History, Directory and terminal settings with simple operation.

As an example, the following shows the operations how to access to Directory menu.

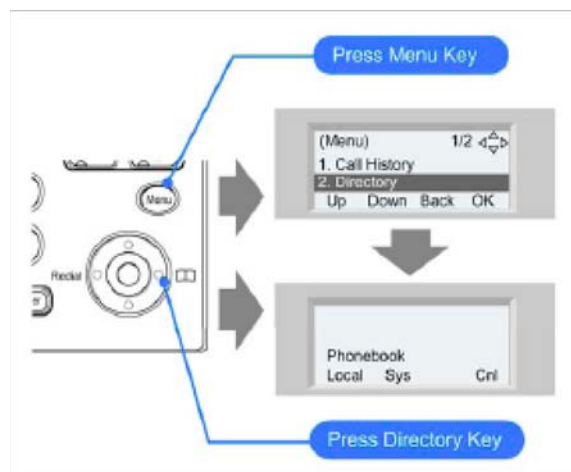



# 2. TERMINAL SETUP

---

This chapter describes operating procedures for terminal settings by the **UP/DOWN** key and **Feature** keys.

Various terminal settings such as display, sounds, password, and language are also available from **Menu** key. For detailed information on terminal settings from **Menu** key, see IP Peripheral Equipment Guide.

## Terminal Setup With the Up/Down Key

### To Adjust Handset Receiver Volume

Press the **Up/Down** key in the off-hook status or during the call.



### To Adjust Speaker Volume

Press the **Up/Down** key during speakerphone operation or during the call.



### To Adjust Ringer Tone

Press the **Up/Down** key during ringing.

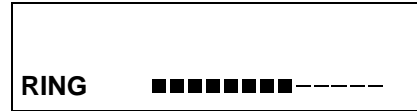

### To Adjust LCD Contrast

Press the **Up/Down** key in the on-hook status.



## Terminal Setup With the Feature Key

### Microphone On/Off

LED on Mic key shows the status of the built-in microphone.

STEP 1: Press **Feature** and 1.

### To Select Ringer Tone

DT Series has 8 kinds of ringer tones that you can select.

### To Change your Extension Incoming Ring Tone

STEP 1: Press **Speaker** and dial **720**.

STEP 2: Dial 1 to set Intercom ring; Dial 2 to set Trunk ring.

**SET INCOM RING**

**1: INT    2: EXT**

STEP 3: Dial code for the desired ring pattern (1~8).

Display below shows when INT is selected.

**SET INT INCOM RING**

**INCOM RING 1-8:?**

STEP 4: Press **Speaker** to hang up.

### To listen to the Incoming ring choices:

STEP 1: Press **Speaker** and Dial 711.

STEP 2: Dial 1 to listen to Intercom ring; Dial 2 to listen to Trunk ring.

STEP 3: For Intercom Ring:  
Dial the code for the ring pattern you want to hear (1-8).

TONE No.	Tone Range
1	High
2	Mid Range
3	Low
4	Ring Tone 1
5	Ring Tone 2
6	Ring Tone 3
7	Ring Tone 4
8	Ring Tone 5

**-OR-**

**For Trunk Ring:**

Dial code for the ring pattern you want to hear (Ring1-3, Melody 4-8). If you select Ring 1-3, a second screen prompts for the tone pattern (1-4).

<b>TONE No.</b>	<b>Tone Range</b>
<b>1</b>	Ring Tone 1
<b>2</b>	Ring Tone 2
<b>3</b>	Ring Tone 3
<b>4</b>	Melody 4
<b>5</b>	Melody 5
<b>6</b>	Melody 6
<b>7</b>	Melody 7
<b>8</b>	Melody 8

STEP 4: Press Speaker to hang up.

This page is for your notes.

# 3. BASIC OPERATION

---

## Login (DT700 Series Only)

When login mode is activated, the following procedure is required.

- Enter login code and press **Set** Softkey.  
(The station number is used as the Login code.)

<b>Login ID :</b>	<b>2000</b>		
<b>Password :</b>			
<b>Cancel</b>	<b>BK</b>	<b>Set</b>	<b>OK</b>

- Enter the password and press **OK** Softkey.

<b>Login ID :</b>	<b>2000</b>		
<b>Password :</b>	<b>*****</b>		
<b>Cancel</b>	<b>BK</b>	<b>Set</b>	<b>OK</b>

- If the login code is accepted, display changes to normal idle status.

<b>28 APR MON 8:45AM</b>			
<b>101</b>	<b>STA 101</b>		
<b>List</b>	<b>Dir</b>	<b>ICM</b>	<b>Prog</b>

## Logout (DT700 Series Only)

- Press the preassigned **Logout** Feature Key on the terminal.

**Note:** *This location is an example.*

**Note:** *Logout button is assigned by data setting at the ECP (Enterprise Communication Platform).*

<b>28 APR MON 8:45AM</b>			
<b>101</b>	<b>STA 101</b>		
<b>List</b>	<b>Dir</b>	<b>ICM</b>	<b>Prog</b>

- “**LOGOUT?**” is displayed on the LCD of the terminal.

<b>LOGOUT ?</b>			
<b>28 APR MON 8:45AM</b>			
<b>101</b>	<b>STA 101</b>		
<b>L-OUT</b>			

- Press the **Logout** Feature Key on the terminal again.

## To Start Security Mode (DT730 Only)

- Press the **Lock** Key on the DT730. The following message is displayed on the LCD.

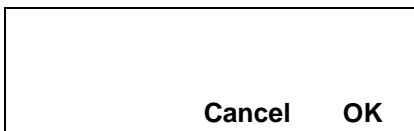

- Press the **OK** Softkey to start Security Mode.

## To Cancel Security Mode

- Display the Password Entry screen by either of the following operations.

- Press any key while the screen server is activated.
- Press the **Lock** Key while the Lock icon is displayed on the LCD.

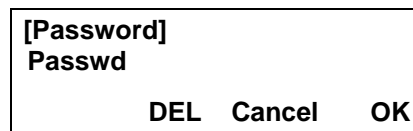

- The Lock Key LED is extinguished and Security Mode is canceled.

# 4. FEATURE OPERATION

---

## ANSWERING CALLS

### Ringing Calls

1. Lift the handset.
2. Start conversation.

**Note:** *When assigning the Delayed Ringing feature, incoming calls will first ring at a primary station. If the call is unanswered after a preprogrammed time interval, calls will also ring at the assigned secondary station.*

### Ringing Calls to a Second Incoming Extension/ CAR/VE Key

1. Lift the handset.
2. Start conversation.

**Note 1:** *A Second Incoming Extension key must be assigned to appear and ring.*

**Note 2:** *A Line key must be available to answer an incoming outside call*

<b>2-11 MON 10:15AM</b>
<b>TALKING TO      STA 12345</b>
<b>Conf</b>

### Answering Outside Calls Using the Answer Key

1. Receive outside call.
2. Press the **Answer** key.
3. Talk with the incoming calling party.
4. When additional outside calls are received, press the **Answer** key to place the current call on hold and connect the multiline terminal user to the next call.

<b>Line 001</b>				
<b>Ringing</b>	<b>Elapsed</b>			
<b>List</b>	<b>Dir</b>	<b>time</b>	<b>ICM</b>	<b>Prog</b>

<b>Line 001</b>	<b>00:10</b>			
<b>Answered</b>				
<b>Conf</b>	<b>Rpt</b>	<b>Save</b>		

## Voice Announce Calls

1. Adjust the **Speaker** volume as needed.

**Note 1:** On SV8100 if MIC key is not lit the user cannot answer voice announce calls without lifting the handset.

2. Respond hands free.

**Note 2:** The handset may be used any time during the conversation.

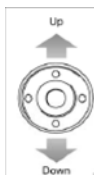

## Camp-on (Call Waiting)

Receive the camp-on tone while on another call:

1. When a Camp On is set from another station, complete the present call and a Call Back will ring the station that set the Camp On.
2. When the Camp On station answers and rings the phone, lift the handset or press the **Speaker** key.

## Off Hook Signaling

With a call in progress:

1. Receive Off-Hook signaling.
2. Press the **Answer** key, then converse with the second party.

2-11 MON 10:56AM
TALKING TO STA 12345
Conf

**Note 3:** The second call may be placed on Hold.

**Note 4:** Press the flashing Line key or Conf key to return to the first call.

## PLACING CALLS

### Internal Calls

1. Lift the handset.
2. Dial a station number or 0 (for attendant).
3. Voice announce after the tone burst, or wait for the ringing call to be answered.

### Outside Calls

1. Lift the handset.
2. Dial the trunk access code (i.e. 9).

**-OR-**

Press an idle Programmable Outside Line key.

3. Dial the telephone number.
4. Converse.

Line 001	00:15		
Conf	Rpt	Save	Trf
2142622000			



## Trunk Queuing

After pressing a busy Line key and receiving the trunk busy indication:

1. Dial # or press **Trunk Queuing/Camp On** key (Service Code 751:35).
2. Replace the handset.

**Note:** *When a line is available, your telephone will ring; lift the handset and place the call.*

## Last CO/PBX Number Redial

1. Without lifting the handset, press the **Redial** key.

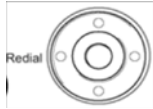

2. To redial the last number, press #.

**-OR-**

Search for the desired number from the Redial List by pressing the **List Softkey** and then the **Redial Softkey**.

3. Press the **Up Arrow/Down Arrow** or **VOLUME UP/VOLUME DOWN** keys to search for the desired number.
4. Lift the handset or press **Speaker** to place the call.

## LIST MENU

Redial CID

## Speed Dial – System/Group/Station

To dial a Station Speed Dial number:

1. Press the **Speaker** key.
2. Dial **#7** (default Service Code).

**Note:** *To preselect, press a Line key in step 1 (instead of Speaker).*

3. Dial the Station Speed Dial buffer number (0~9):

1 = Station Speed Dial buffer 1  
2 = Station Speed Dial buffer 2  
:  
:  
0 = Station Speed Dial buffer 10

**Note 1:** *The stored number dials out.*

**Note 2:** *Unless you preselect, Trunk Group Routing selects the trunk for the call. The system may optionally select a specific Trunk Group for the call.*

**Note 3:** *If you have a DSS Console, you may be able to press a DSS Console key to chain to a stored number.*

To dial a Station Speed Dialing number:

1. Press the **Speaker** key.
2. Dial **#2** (default Service Code).

**-OR-**

Press the **Redial** key.

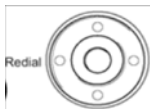

**-OR-**

Press the **System Speed Dialing** key (Service Code 751:27).

**Note:** *To preselect, press a Line key in step 1 (instead of pressing Speaker).*

3. Dial the Station Speed Dial buffer number (Default: 000~999).

The stored number dials out.

2-13 WED 5:28PM			
92142622000		NEC	
Conf	Rpt	Save	Trf

**Note 1:** *Initially (at default), there are 1000 System Speed Dial buffers.*

**Note 2:** *Unless you preselect, Trunk Group Routing selects the trunk for the call. The system may optionally select a specific Trunk Group for the call.*

**Note 3:** *If you have a DSS Console, you may be able to press a DSS Console key to chain to a stored number.*

To dial a Group Speed Dialing number:

1. Press the **Speaker** key.
2. Dial **#4** (default Service Code).

**-OR-**

Press the **Redial** key.

**-OR-**

Press the **Group Speed Dialing** key (Service Code 751:28).

**Note:** *To preselect, press a Line key in step 1 (instead of pressing Speaker).*

3. Dial the Group Speed Dial buffer number ( none at default).

**Note 1:** *Initially, there are no Group Speed Dial buffers assigned.*

**Note 2:** *Unless you preselect, Trunk Group Routing selects the trunk for the call. The system may optionally select a specific Trunk Group for the call.*

**Note 3:** *If you have a DSS Console, you may be able to press a DSS Console key to chain to a stored number.*

## MICROPHONE CONTROL

1. Press the **MIC** key.
2. A lit **MIC** LED indicates that the **MIC** is on.

## SPEAKERPHONE CALLS

1. Press the **Speaker** key and the Speaker LED lights.
2. Ensure that the **MIC** LED is lit.
3. Place an internal or outside call.
4. Converse.
5. Press the **Speaker** key to disconnect the call.

**Note:** *The handset may be used at any time during the conversation. To resume handsfree operation or to monitor a call, press the **Speaker** key (the Speaker LED lights) and replace the handset.*

## GROUP LISTEN

To initiate Group Listen:

1. Place or answer a call using the handset.
2. Press the **Speaker** key twice (do not hang up).

**Note 1:** *The Speaker LED flashes.*

**Note 2:** *You can talk to the caller through the handset. Your coworkers hear your caller's voice over your telephone's speaker.*

**Note 3:** *When you press the **Speaker** key once, you turn your Speakerphone on. The second press turns on Group Listen. Pressing the **Speaker** key a third time cancels the Group Listen feature.*

<b>2-13 WED 5:40PM</b> <b>GROUP LISTEN</b> <b>Conf</b>
--

## HOLDING CALLS

### System Hold –

With a call in progress:

1. Press **Hold**.

### Exclusive Hold –

With a call in progress:

1. Press the **Exclusive Hold** key (Service Code 751:45).

**Note 1:** *To retrieve a held call, press the flashing Line key or ICM key (Internal calls).*

**Note 2:** *Calls on System Hold can be retrieved from any multiline terminal with the held line appearance.*

**Note 3:** *After a preprogrammed time, the held call will recall to the originating station.*

2-13 WED 5:40PM			
HOLD	STA 12345678		
InPg	ExPg	P/U	↓

## TRANSFERRING CALLS

### Using Manual Dial –

With a call in progress:

1. Press the **Transfer** key.
2. Dial the station number.

3. Announce the call (optional).

4. Replace the handset.

### Using Direct Station Selection (DSS) –

With a call in progress:

1. Press the **Transfer** key.
2. Press the programmed DSS.
3. Announce the call (optional).
4. Replace the handset.

**Note 1:** *If the called station is busy, replace the handset to initiate a camp-on. Unanswered camp-on calls and unscreened transfers will recall to the transferring station.*

**Note 2:** *To return to the original party, press the flashing Line key or Conf key.*

**Note 3:** *A Programmable Function Key may be assigned for DSS.*

**Note 4:** *To transfer a call directly to a personal voice mailbox, dial 8 after dialing the station number.*

2-13 WED 5:40PM			
HOLD	STA 12345678		
InPg	ExPg	P/U	↓

## CONFERENCE

1. Establish an intercom or trunk call.
2. Press the **Conf Softkey** or the **Conference** key (Service Code 751:07).
3. Dial the extension you want to add.

**-OR-**

Access an outside call.

**Note:** *To get the outside call, you can either press a Line key or dial a trunk/trunk group access code.*

4. When the called party answers, press the **Conference** key twice.

**Note:** *If you cannot add additional parties to your conference, you have exceeded the system's Conference limit.*

5. Repeat steps 2~4 above to add more parties.

<b>2-11 MON 10:56AM</b> <b>TALKING TO STA 12345</b> <b>Conf</b>
---

<b>ICM DIAL</b> <b>AnHd Dir</b>	<b>CONF</b>
------------------------------------	-------------

## CALL PARK – SYSTEM

To Park a call in a system orbit:

**Note:** *You can Park intercom or trunk calls.*

1. Press the **Park** key (Service Code 752: \*04 + orbit).

**Note:** *The Park key LED lights.*

2. Use Paging to announce the call.
3. Press the **Speaker** key to hang up.

**Note:** *If not picked up, the call will recall you.*

**-OR-**

1. Press the **Transfer** key.

2. Dial **#6** and the Park orbit (01~64).

**Note:** *If you hear a busy tone, the orbit is busy. Try another orbit.*

3. Use Paging to announce the call.
4. Press the **Speaker** key to hang up.

**Note:** *If not picked up, the call will recall you.*

<b>PARK HOLD</b> <b>Park No. Dial</b>
--

To pick up a Parked call:

1. Lift the handset.
2. Press the **Park** key (Service Code 752: \*04 + orbit).

**-OR-**

1. Press the **Speaker** key.
2. Dial \*6 and the Park orbit (01~64).

ANS HOLD

Park No. Dial

## STATION BUSY/NO ANSWER OPTIONS

### Callback

To place a callback:

1. Call an unavailable (busy or unanswered) extension.
2. Dial # or press the **Callback** key (Service Code 751:35).
3. Hang up.
4. Lift the handset when the busy extension calls you back.

**Note 1:** *If the unavailable extension was unanswered (not busy), the Callback goes through after your co-worker uses their telephone for the first time.*

**Note 2:** *If you have Callback Automatic Answer, you automatically place a call to the formerly busy extension when you lift the handset. If you do not have Callback Automatic Answer, you must press the ringing line appearance to place the call.*

To cancel a Callback:

1. Press the idle **Speaker** key and dial 770.

**-OR-**

Press the **Camp-On** key (Service Code 751:35).

2-14 THU 3:15PM  
CAMP-ON STA 12345678

## Message Waiting

To leave a Message Waiting:

1. Call a busy or unanswered extension.
2. Dial **0** or press the **Message Waiting** key (Service Code 751:38).
3. Hang up.

<b>2-14 THU 3:15PM</b> <b>MSG &gt;&gt;&gt; STA 12345678</b>
--

To answer a Message Waiting:

**Note:** *When you have a message, your Message Waiting LED flashes.*

1. Press the **Speaker** key and dial **\*0**.

**-OR-**

Press the **MW softkey** or **Message Waiting** key (Service Code 751:38).

<b>2-14 THU 3:15PM</b> <b>12345678 STA 12345678</b> <b>MW Menu</b>
--

<b>MW from STA 12345678</b> <b>Call Cncl</b>
---

**Note:** *If the called extension does not answer, dial 0 or press your Message Waiting key to automatically leave a message.*

To cancel all your Messages Waiting:

**Note:** *This includes messages you have left for other extensions and messages other extensions have left for you.*

1. Press the **Speaker** key.
2. Dial **773**.
3. Hang up.

To cancel the Messages Waiting you have left at a specific extension:

1. Press the **Speaker** key.
2. Dial **771**.
3. Dial the number of the extension you do not want to have your messages.
4. Hang up.

**-OR-**

Press the **Cncl Softkey**.

## Tone Override

To send off hook signals to an extension busy on a call:

**Note:** *Your extension may send off hook signals automatically.*

1. Dial \*.

**-OR-**

Dial **709**.

2. Press the **Off Hook Signaling** key (Service Code 751:33).

**Note 1:** *You hear Ring Busy Tone.*

**Note 2:** *The called extension hears Call Alert Notification.*

To answer Tone Override:

1. Receive Tone Override.
2. Press the **Hold** key and talk with the party.

<p><b>2-14 THU 3:15PM</b> <b>CALLING STA 12345678</b> <b>Voice MW</b></p>
---

## Department Step Call

To make a Step Call:

1. Place a call to a busy Department Group member.

**-OR-**

Place a call to a Department Group pilot number.

2. Dial Department Step Code (2) to call the next available Department Group member.
3. Repeat step 2 to call other Department Group members.

## Voice Over

To initiate a Voice Over to a busy extension:

1. Press the **Voice Over** key (Service Code 751:48).

**-OR-**

Dial **6**.

**Note:** *You hear an alert tone and the Voice Over key flashes. You can talk to the called party after the alert tone ends.*



To respond to a Voice Over alert tone to your extension:

**Note:** *You can only respond if you have a **Voice Over** key.*

1. Press the **Voice Over** key (Service Code 751:48).

**Note:** *The Voice Over key lights steadily (green) and you can talk to the interrupting party.*

To return to your original call:

1. Press the **Voice Over** key.

**Note 1:** *Your Voice Over key flashes red when you are talking to your original call.*

## CO/PBX DIALING OPTIONS

### Save Number Dialed

To save the outside number you just dialed (up to 24 digits).

**Note:** *Use this feature before hanging up.*

1. Press the Save Number Dialed key (Service Code 751:30).

To redial a saved number:

1. Press an idle trunk line key.

**Note:** *This selects a specific trunk for the call.*

2. Press the **Save Number Dialed** key (Service Code 751:30).

<b>PREVIEW</b>	<b>SAVED NUMBER</b>		
<b>List</b>	<b>Dir</b>	<b>ICM</b>	<b>Prog</b>

**Note:** *The stored number dials out.*

**-OR-**

1. Press the **Speaker** key.

2. Dial **715**.

**Note 1:** *Save Number Dialed automatically selects a trunk from the same group as your original call.*

**Note 2:** *The stored number dials out.*

### Memo Dial

To store a number while you are on a call:

1. While on a call, press the **Memo Dial** key (Service Code 751:31).

2. Dial the number you want to store.

3. Press the **Memo Dial** key again and continue with the conversation.

To call a stored Memo Dial number:

1. Do not lift the handset.
2. Press the **Memo Dial** key (Service Code 751:31).
3. Press the **Speaker** key.

**-OR-**

Press a configured Line key.

**Note:** *The stored number dials out.*



To check to see the stored Memo Dial number:

1. Do not lift the handset.
2. Press the **Memo Dial** key (Service Code 751:31).

**Note:** *The stored number displays.*

3. Press **Exit** to return to the main LCD screen.

To cancel (erase) a stored Memo Dial number:

1. Press the **Speaker** key.
2. Press the **Memo Dial** key (Service Code 751:31).

## Repeat Redial

To use Repeat Redial (if the outside party you call is unavailable or busy):

1. Place a trunk call.

**Note:** *Listen for busy tone or Ring-No Answer.*

2. Press the **Feature + Redial** keys.

**-OR-**

Press the **Repeat Redial** key (Service Code 751:29).

**Note:** *The Repeat Redial key lights while you wait for the system to redial.*

3. Press the **Speaker** key to hang up.

**Note 1:** *The system periodically redials the call.*

**Note 2:** *System programming determines the waiting time and the number of redial attempts.*

4. Lift the handset when the called party answers.

**Note:** *When using trunks with answer supervision, the Repeat Redial feature automatically cancels.*

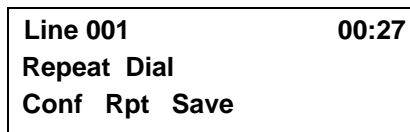

To cancel Repeat Redial:

1. Press the **Feature** key.
2. Press the **Redial** key.

**-OR-**

Press the Repeat Redial key (Service Code 751:29).

2-14 THU 3:15PM			
Cancel Repeat Dial			
List	Dir	ICM	Prog

### Caller ID

#### Answer

Receive incoming ringing or a transferred outside call:

1. Review the telephone display for the calling party's name or number.
2. Answer the call accordingly.

### Temporary Memory

An unanswered call will cause the **Call History** key (Service Code 751:08) to flash, indicating a new call has been placed in the temporary memory. If enabled in programming, the telephone's display will show: "**Check List**".

Line 001			
NEC America 2142622000			
Conf	Dir	ICM	Prog

1. Press the **Call History** key (Service Code 751:08) or press the **LIST** Softkey and CID.

**Note:** *The last addition to the list is displayed.*

2. Press the **Arrow Down** Softkey to scroll through the list of numbers in memory.
3. Press the **DEL** Softkey to delete the entry and scroll to the next entry.
4. The **Call History** key will remain on as long as entries remain in memory.
5. To place a call back to a number in the temporary memory list, with the number to be dialed displayed, press a Line or the **Speaker** key.

**Note:** *The outgoing call is placed.*

2-14 THU 4:32PM			
12345678			
Conf	Dir	ICM	Prog

LIST MENU			
Redial	CID		

## CALL PICKUP

### Group Call Pickup

To answer a call ringing another telephone in your Pickup Group:

1. Pick up the handset or press the **Speaker** key.
2. Press the **Group Call Pickup** key (Service Code 751:24).

**-OR-**

Dial **756** or **\*#**.

**Note:** *Service Code \*# can pick up any call in the group, plus any Ring Group calls. Service Code 756 cannot pick up Ring Group calls.*

<b>2-14 THU 4:32PM</b> <b>Call P/U STA 87654321</b> <b>Conf</b>
---

To answer a call ringing a telephone in another Pickup Group when you do not know the group number:

1. Pick up the handset or press the **Speaker** key.
2. Press the **Group Call Pickup** key (Service Code 751:25).

**-OR-**

Dial **769**.

To answer a call ringing a telephone in another Pickup Group when you know the Group Number:

1. Pick up the handset or press the **Speaker** key.
2. Press the **Group Call Pickup** key (Service Code 751:26 + group).

**-OR-**

Dial **768** and the group number (0~9 or 00~64).

<b>2-14 THU 4:32PM</b> <b>Group No.</b>
--

## Directed Call Pickup

To use Directed Call Pickup to intercept a call to a coworker's extension:

1. Pick up the handset or press the **Speaker** key.
2. Dial \*\*.
3. Dial the number of extension whose call you want to intercept.

**Note:** *If more than one call is coming in, the system sets the priority for which call it answers first.*

<b>2-14 THU 4:32PM</b> <b>ICM DIAL                    12345678</b>
---

<b>2-14 THU 4:20PM</b> <b>TALKING TO   STA 12345678</b> <b>Conf</b>
---

## PAGING

To make an Internal Page announcement:

1. Press the zone's **Internal Paging** key [Service Code 751:21, 01~64 for zones (00 for All Call)].

**-OR-**

1. Press the **Speaker** key or lift the handset.
2. Dial **701** and the Paging Zone number (0~9 or 00~64).

**Note:** *Dialing 0 or 00 calls All Call Internal Paging.*

3. Dial \*1 and the Combined Paging Group code 1~8 or 0 (for Internal/External All Call).

**Note:** *The display indicates the Combined Paging as an External Page.*

**Note:** *If the Internal Page Zone is busy or if there are no extensions in a page group, the page will be announced as an External Page only.*

<b>2-14 THU 4:32PM</b> <b>GROUP No.</b>
--

<b>2-14 THU 4:32PM</b> <b>PAGE EXT                    GROUP</b>
--

4. Make an announcement.

5. Press the **Speaker** key to hang up.

To Page an External Zone:

1. Press the **External Paging** key (Service Code 751:19 for External Paging zones or 20 for External All Call Paging).

2. Make the announcement.

**-OR-**

1. Press the **Speaker** key or pick up the handset.

**-OR-**

2. Dial **703** and the External Paging Zone code (1~8 or 0 for All Call).

<b>2-14 THU 4:20PM</b> <b>ZONE</b>
---------------------------------------

<b>2-14 THU 4:20PM</b> <b>PAGE EXT Group</b>
---

**-OR-**

Dial \*1 and the Combined Paging Group code (1~8 or 0 for Internal/External All Call).

**Note:** *The display indicates the Combined Paging as an External Page.*

**Note:** *If the Internal Page Zone is busy or if there are no extensions in a page group, the page will be announced as an External Page only.*

3. Make the announcement.

### **Meet Me Answer**

To join a Meet Me Internal Page:

1. Press the **Speaker** key or pick up the handset.

2. Dial **763** (if your extension is in the zone called).

**-OR-**

Dial **764** and the zone number (if your extension is not in the zone called).

**-OR-**

Press the **Meet Me Conference/Paging Pickup** key (Service Code 751:23) if your extension is in the zone called.

**Note:** *You connect to the other party.*

To join a Meet Me External Page:

1. Press the **Speaker** key or pick up the handset.
2. Dial **765**.
3. Dial the announced External Paging Zone (0~8).

**Note:** *You connect to the other party.*

## BACKGROUND MUSIC

To turn Background Music on or off:

1. Press the **Speaker** key.
2. Dial **725**.
3. Press the **Speaker** key to hang up.

2-14 THU 4:20PM  
B.G.M. ON

## CALL FORWARDING

### All Calls (CF/A)

To set Call Forward – Immediate at a forwarding station:

1. Pick up the handset or press the **Speaker** key.
2. Dial the **Call Forward – Immediate Service Code** (default: 741).

**-OR-**

Press the **Call Forwarding Programmable Function Key** (Service Code 751:10).

CF-ALL  
1:SET 0:CANCEL

3. Dial 1 (Set)

CF-ALL

4. Dial the destination extension or off-premise number.
- 5.

CF-ALL  
92142622000

6. Press the Speaker key or hang up.

**Note:** *Your Call Forwarding Programmable Function Key lights.*

To cancel Call Forward – Immediate at a forwarding station:

1. Pick up the handset or press the **Speaker** key.
2. Dial the **Call Forward – Immediate Service Code** (default: 741).

**-OR-**

Press the **Call Forwarding Programmable Function Key** (Service Code 751:10).

3. Dial **0**.
4. Press the **Speaker** key or hang up.

**Note:** *Your Call Forwarding Programmable Function Key goes off.*

### **Call Forwarding Busy/No Answer (B/NA)**

To set Call Forward – Busy/No Answer at a forwarding station:

1. Pick up the handset or press the **Speaker** key.
2. Dial the **Call Forward – Busy/No Answer Service Code** (default: 744).

**-OR-**

Press the **Call Forwarding Programmable Function Key** (Service Code 751:13).

<b>CF-BNA</b> <b>1:SET 0:CANCEL</b>
--

<b>CF-BNA</b> <b>12345678</b>
----------------------------------

3. Dial **1** (Set).

4. Dial the destination extension or off-premise number.
5. Press the **Speaker** key or hang up.

To cancel Call Forward – Busy/No Answer at a forwarding station:

1. Pick up the handset or press the **Speaker** key.
2. Dial the **Call Forward – Busy/No Answer Service Code** (default: 744).

**-OR-**

Press the **Call Forwarding Programmable Function Key** (Service Code 751:13).

3. Dial **0** (Cancel).
4. Press the **Speaker** key or hang up.

To set Call Forward – Both Ring at a forwarding station:

1. Pick up the handset or press the **Speaker** key.
2. Dial the **Call Forward – Both Ring Service Code** (default: 745).

**-OR-**

Press the **Call Forwarding Programmable Function Key** (Service Code 751:14).

3. Dial **1** (Set).
4. Dial the destination extension number.



**CF-Both Ring**  
12345678

To cancel Call Forward – Both Ring at a forwarding station:

1. Pick up the handset or press the **Speaker** key.
2. Dial the **Call Forward – Both Ring Service Code** (default: 745).

**-OR-**

Press the **Call Forwarding Programmable Function Key** (Service Code 751:14).

3. Dial **0** (Cancel).
4. Press the **Speaker** key or hang up.

## SELECTABLE DISPLAY MESSAGING

To select a message:

1. Press the **Speaker** key.
2. Press the **Text Message** key (Service Code 751:18 + 01~20).

**IN MEETING UNTIL 08:48**  
**STA 12345678**

List Dir ICM Prog

3. Use **VOL UP** or **VOL DOWN** keys to scroll through the messages.
4. For messages 1~8 and 10, enter digits to append the message, if needed.

**Note:** *You can append messages 1~8 and 10 with digits (e.g. the time when you get back). You enter the time in 24-hour format.*

No.	Message	Change “#” to:
1	IN MEETING UNTIL ##:##	Time (when meeting is done)
2	MEETING ROOM - #####	Room name or extension
3	COME BACK ##:##	Time (when returning)
4	PLEASE CALL #####	11 digits (Tel. No.)
5	BUSY CALL AFTER ##:##	Time (when returning)
6	OUT FOR LUNCH BACK ##:##	Time (when returning)
7	BUSINESS TRIP BACK ##:##	Date (when returning)
8	BUSINESS TRIP #####	10 digits (where reached)
9	GONE FOR THE DAY	
10	ON VACATION UNTIL ##:##	Date (when returning)
11~20	MESSAGE 11~20	

5. Press **Speaker** to hang up.

**Note:** *Intercom calls to extensions with Selectable Display Messaging set will receive a DND signal and receive the display message on their telephone’s display instead of ringing the display.*

**Note:** *To allow calls to ring through and have the message displayed on the calling extension's display, cancel DND by pressing the DND key + 0 (DND key (Service Code 751: Code 03).*

To cancel a message:

1. Press the **Speaker** key.
2. Press the **Text Message** key (Service Code 751:18+).
3. Press Speaker to hang up.

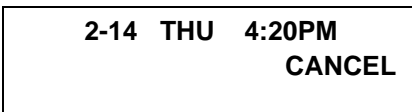

## STATION RELOCATION

To exchange two terminals:

1. Pick up the handset or press the **Speaker** key.
2. Dial the **Extension Data Swap Service Code** – not assigned at default.
3. Dial the **Extension Data Swap Password** – not assigned at default.
4. Dial the extension to be swapped with or relocated to.
5. When successfully completed, a confirmation tone will be heard and the display will show “completed”.

6. Press the **Speaker** key twice.

## CODE RESTRICTION, DIAL BLOCK

To set Dial Block:

1. Press the **Speaker** key.
2. Dial **600** (default).
3. Dial the **4-digit Dial Block Code** (user defined).
4. Dial **1**.

**Note:** *The confirmation tone is heard.*

5. Press the **Speaker** key to hang up.

To release Dial Block:

1. Press the **Speaker** key.
2. Dial **600**.
3. Dial the **4-Digit Block Code**.
4. Dial **0**.

**Note:** *The confirmation tone is heard.*

5. Press the **Speaker** key to hang up.

**Note:** *At default, Dial Block restriction Class per Extension is denied.*

## ACCOUNT CODE ENTRY

To enter an Account Code any time while on a trunk call:

The outside caller cannot hear the Account Code digits you enter. You can use this procedure if your system has Optional Account Codes enabled. You may also be able to use this procedure for incoming calls.

1. Dial \*.

**-OR-**

Press your **Account Code** key  
(Service Code 751:Code 50).

2. Dial your Account Code (1~16 digits, using 0~9 and #).

<b>LINE 001</b>
<b>Enter Account Code</b>
<b>Conf Rpt Sav Trf</b>

**Note:** *If Account Codes are hidden, each digit you dial shows as a "\*" character on the telephone's display.*

3. Dial \*.

**-OR-**

Press your **Account Code** key  
(Service Code 751:Code 50).

To enter an Account Code before dialing the outside number:

If your system has Forced Account Codes, you must use this procedure. If it has Verified Account Codes, you can use this procedure instead of letting the system prompt you for your Account Code. You may also use this procedure if your system has Optional Account Codes. If your system has Verified Account Codes enabled, be sure to choose a code programmed into your Verified Account Code list.

1. Access trunk for outside call.

**Note:** *You can access a trunk by pressing a Line key or dialing a code (except 9).*

2. Dial \*.

**-OR-**

Press your **Account Code** key (Service Code 751:Code 50).

3. Dial your Account Code (1~16 digits, using 0~9 and #).

**Note:** *If you make an incorrect entry, your system may automatically alert the operator. If Account Codes are hidden, each digit you dial will show as a "\*" character on the telephone's display.*

4. Dial \*.

**-OR-**

5. Dial the number you want to call.

**Note:** *If you hear “stutter” dial tone after dial the number, ARS is requesting that you enter an Automatic Route Selection Authorization Code.*

## AUTOMATIC CALL DISTRIBUTION (ACD)

### Agent Log In

To log in:

1. Press the **ACD LOG IN/LOG OUT** key (Service Code 752: \*10).

**-OR-**

Press the **Speaker** key and dial the Log In Service Code (Default \*5).

2. Dial the log in code (up to 20 digits).

**Note:** *This step is not required if the ID code is disabled.*

Display before Agent login

<b>WAIT ACD LOGIN</b>	<b>G:01</b>		
<b>12345678</b>	<b>STA 12345678</b>		
<b>List</b>	<b>Dir</b>	<b>ICM</b>	<b>Prog</b>

Display after Agent login

<b>Group</b>	<b>G:01</b>
<b>12345678</b>	<b>STA 12345678</b>

Agent Log Out display

<b>ACD LOGOUT?</b>
<b>(1:Yes; 0:No)</b>

### AIC Agent Log In

To log in:

1. Press the **ACD LOG IN/LOG OUT** key (Service Code 752: \*10).

**-OR-**

Press the **Speaker** key and dial the **AIC Log In** service code – not assigned at default.

2. Dial the log in code (up to 20 digits).

**Note:** *This step is not required if the ID code is disabled.*

3. Dial the **Agent Identity Code** (AIC – up to four digits).

<b>Input AIC</b>			
<b>List</b>	<b>Dir</b>	<b>ICM</b>	<b>Prog</b>

**Note:** *The ACD LOG IN/LOG OUT key lights.*

Display before Agent login

2-15 FRI 11:02PM			
12345678		STA	12345678
<b>List</b>	<b>Dir</b>	<b>ICM</b>	<b>Prog</b>

Display after Agent login

2-15 FRI 11:02PM			
12345678			Login
<b>List</b>	<b>Dir</b>	<b>ICM</b>	<b>Prog</b>

## Multiple AIC Agent Log In

To log in:

1. Press the **ACD LOG IN/LOG OUT** key (Service Code 752: \*10).

**- OR -**

Press the **Speaker** key and dial the **AIC Log In** service code -not assigned at default.

2. Dial **0** to cancel the log out option.
3. Dial the **Agent Identity Code** (AIC) (up to four digits).

**Note:** *The ACD LOG IN/LOG OUT key lights.*

4. Repeat steps 3 and 4, if more log ins are required.

To log out (for single or multiple agent AIC log In):

**Note:** *All AIC log in become logged out.*

1. Press the **ACD LOG IN/LOG OUT** key (Service Code 752: \*10) + 1 to accept.
2. Press the **Speaker** key and dial the **AIC Log In** service code – not assigned at default.

**Note:** *The ACD LOG IN/LOG OUT key goes out.*

## Rest Mode

To set the manual Rest Mode:

1. From an idle state, press the **ACD Rest Mode** key (Service Code 752: \*13).

**Note:** *The ACD Rest Mode key lights. If the Rest Mode key is pressed while the agent is on an active call, the key will flash until the agent hangs up.*

**Note:** *This operation is not available for the System Supervisor.*

Group No: 01			
12345678			OFF DUTY
<b>List</b>	<b>Dir</b>	<b>ICM</b>	<b>Prog</b>

To cancel the manual Rest Mode:

1. Press the **ACD Rest Mode** key (Service Code 752: \*13).

**Note:** *The ACD Rest Mode key light goes off.*

### Queue Status Display

When Logged Into ACD Group:

1. From an idle state, press the **Queue Status Display** key (Service Code 752: \*19).

Group No: 01			
0-----00:05			
<b>List</b>	<b>Dir</b>	<b>ICM</b>	<b>Prog</b>

**Note:** *The display indicates the number of calls in queue, the trunk name, and the length of time the call has been waiting.*

**Note:** *When the Queue Status Display key is pressed, the queue status of the extension's group is displayed. When the extension is not in an ACD group, the Queue Status of group 1 is displayed instead.*

**Note:** *When an agent logs in using an AIC code, the Queue Status of the default ACD group is displayed.*

2. Press **Volume Up** and **Volume Down** to scroll through the Queue Status Displays of all the ACD Groups.
3. Press the **CLEAR** key to return the telephone to an idle state.

When Logged Out of ACD Group:

When ACD agents are logged out and a call is placed into the ACD queue, the telephones of the logged out agents will display the Queue Status and hear the alarm according to the settings defined in system programming.

Pressing the Queue Status Display key will return the telephone to idle until the timer expires again.

### Answering a Call Using a Headset

1. Press the **Headset** key to answer.
2. Converse.
3. Press the **Headset** key to hang up.

## Using the Headset with Automatic Answer for ACD Agents:

1. With the multiline terminal in an idle state, press the **Feature** key.
2. Press the **HEADSET** key (Service Code 751: 05).

**Note:** *The Headset key blinks when Automatic Headset is activated.*

**Note:** *To cancel Automatic Headset, repeat these steps.*

## Station Speed Dial – Dial Access

To store a Station Speed Dialing number (display telephones only):

1. Press the **Speaker** key.
2. Dial **755**.
3. Dial the Station Speed Dial buffer number to be programmed (0~9).

1 = Station Speed Dial buffer 1

2 = Station Speed Dial buffer 2

:

:

0 = Station Speed Dial buffer 10

4. Dial the **Access Code** (e.g., 9) – if required.
5. Dial telephone number you want to store (up to 24 digits).

**Note:** *Valid entries are 0~9, # and \*. To enter a pause, press **MIC**. To store a Flash, press **Recall**.*

6. Press **Hold**.
7. Enter the name associated with the Speed Dialing number (display telephones only):

Use this keypad digit....	Key for Entering Names When you want to....
1	Enter characters: 1 @ [ ¥ ] ^ _ ` {   } Æ ¨ Á À Â Ã Ç È É Ê Ì Ó
2	Enter characters: A-C, a-c 2
3	Enter characters: D-F, d-f, 3
4	Enter characters: G-I, g-l, 4
5	Enter characters: J-L, j-l, 5
6	Enter characters: M-O, m-o, 6
7	Enter characters: P-S, p-s, 7
8	Enter characters: T-V, t-v,8
9	Enter characters: W-Z, w-z,9
0	Enter characters: 0 ! “ # \$ % & ’ ( ) ô õ ú ü ä ö ü á â è
*	Enter characters: + , - . / : ; < = > ? B E ó S ç £
#	# = Accepts an entry (only required if two letters on the same key are needed – ex: TOM). Pressing # again = Space.
Conf	Clears all the entries from the point of the flashing cursor and to the right (used when entering the Name).
Exit	Clears all the entries from the point of the flashing cursor and to the right (used when entering the Number, this clears both the number and name).

8. Press **Hold**.

9. Press the **Speaker** key to hang up.

### Line Keys/Programmable Function Keys

The following functions can be assigned to Line Keys if allowed by Class of Service.

To Program a Line key as a Programmable Function Key:

1. Press the **Speaker** key.
2. Dial Service Code **751**.
3. Press the **Line Key** to be programmed.
4. Dial the code for the desired feature plus additional data if required.
5. Press **Speaker** to hang up.

**Note 1:** *Service Code 00 will erase the function from the key.*

**Note 2:** *In some cases, the **Hold** key needs to be pressed before pressing the **Speaker** key.*



Function Number	Function	Additional Data
00	Not Defined	
01	DSS / One-Touch	Extension number or any numbers (up to 24 digits). Press HOLD to write.
02	Microphone Key (ON/OFF)	
03	DND Key	
04	BGM (ON/OFF)	
05	Headset	
06	Transfer Key	
07	Conference Key	
08	Incoming Call Log	
09	Day/Night Mode Switch	Mode Number (1-8)
10	Call Forward – Immediate	
11	Call Forward-Busy	
12	Call Forward – No Answer	
13	Call Forward – Busy/No Answer	
14	Call Forward – Both ring	
15	Follow Me	
16	--Not Used--	
17	--Not Used--	

Function Number	Function	Additional Data
18	Text Message Setup	Message Numbers (01-20)
19	External Group Paging	External Paging Number (1-8)
20	External All Call Paging	
21	Internal Group Paging	Internal Paging Number (01-64)
22	Internal All Call Paging	
23	Meet-Me Answer to Internal Paging	
24	Call Pickup	
25	Call Pickup for Another Group	
26	Call Pickup for Specified Group	Call Pickup Group Number
27	Speed Dial – Common / Private	Speed Dial Number (Common / Private)
28	Speed Dial – Group	Speed Dial number (Group)
29	Repeat Redial	
30	Saved Number Redial	
31	Memo Dial	
32	Meet – Me Conference	
33	Override (Off-Hook Signaling)	

Function Number	Function	Additional Data
34	Break – In	
35	Camp On	
36	Step Call	
37	DND / FWD Override Call	
38	Message Waiting	
39	Room Monitoring	
40	Handset Transmission Cutoff	
41	Buzzer	Extension Number
42	Boss – Secretary Call	Extension Number
43	Series Call	
44	Common Hold	
45	Exclusive	
46	Department Group Log Out	
47	Reverse Voice over	Extension Number
48	Voice Over	Extension Number
49	Call Redirect	Extension Number or Voice Mail Number
50	Account Code	
51	General Purpose Relay	Relay No (0, 1-8)
52	Automatic Answer with Delay Message Setup	

Function Number	Function	Additional Data
53	Automatic Answer with Delay Message Start	
54	External Call Forward by Door Box	
55	Extension Name Change	
56	General Purpose LED Operation	
57	General Purpose LED Indication	
58	Automatic Transfer at Department Group Call	Extension Group Number (1-8 or 01-64)
59	Delayed Transfer at Department Group Call	Extension Group Number (1-8 or 01-64)
60	DND at Department Group Call	Extension Group Number (1-8 or 01-64)
61	--Not Used--	
62	--Not Used--	
63	Outgoing Call Without Caller ID (ISDN)	
64	--Not Used--	
65	--Not Used--	
66	CTI	

Function Number	Function	Additional Data
67	--Not Used--	
68	--Not Used--	
69	--Not Used--	
70	--Not Used--	
71	--Not Used--	
72	Keypad Facility Key	
73	Keypad Hold Key	
74	Keypad RETRIEVE Key	
75	Keypad Conference Key	
76	--Not Used--	
77	Voice Mail (In-Skin)	Extension Number or Pilot Number
78	Conversation Recording – Voice Mail	
79	Automated Attendant (In-Skin)	Extension Number or Pilot Number
80	Tandem Ringing	1=Set 0=Cancel Extension Number to Tandem Ring
81	Automatic Transfer to Transfer Key	Trunk Line No. (001-200)
82	Dterm IP Call Log	

Function Number	Function	Additional Data
83	Conversation Recording Function (VMSU)	0=Pause 1=Re-recording 2=Address 3=Erase 4=Urgent Page
84	Drop Key	
85	Directory Dialing	
86	Private Call Refuse	
87	Caller ID Refuse	
88	Dial-In Mode Switching	
89	--Not Used--	
90	--Not Used--	
91	Live Recording Key	
94	Call Attendant	
97	97: Doorphone (1-8:Doorphone No.)	

This page is for your notes.

# 5. DIRECTORY OPERATION

---

This chapter explains about the Directory function of DT Series. By using Directory function, the user can make a call with simple operation.

Directory function can register up to 500 records. The user can add/view/edit/delete these records.

- [Add New Data](#)
- [Find Registered Data](#)
- [Make a Call From Directory](#)
- [Delete All Directory Data](#)
- [Delete Specific Directory Data](#)

## Add New Data

STEP 1: Press **Menu** key. The menu screen is displayed in LCD.

STEP 2: Select **2. Directory** by using Cursor Key, Digit Key (2) or Softkey. (DT7XX menu shown)

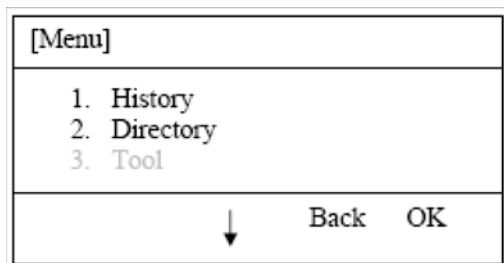

STEP 3: Select **1. REGIST** by using Cursor Key, Digit Key (1) or Softkey.

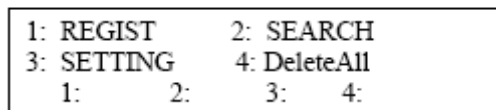

STEP 4: Select Name or Telephone Number by using Alpha or Num Softkey to toggle between the two.

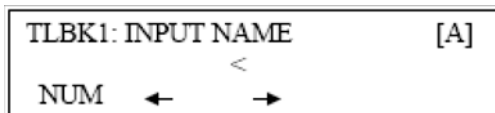

STEP 5: Enter a name or telephone number to be registered in the directory using the dial pad.

STEP 6: After entering the name or telephone, press the **Hold** key.

STEP 7: The following list appears. Select a desired group by entering a number.

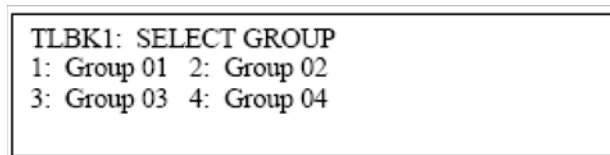

STEP 8: Enter the telephone number as indicated in the display and press the **Hold** key.

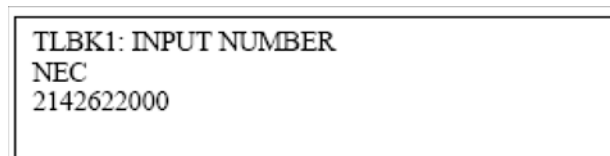

STEP 9: Enter a desired Memory ID.

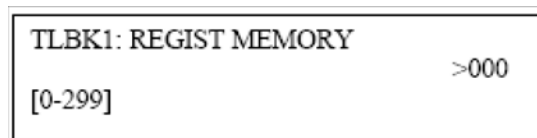

STEP 10: After entering the Memory ID, the display goes back to the main directory screen. Press exit to go back to the main screen.

## Find Registered Data

STEP 1: Press **Menu** Key. The menu screen is displayed in the LCD. (DT7XX menu shown)

[Menu]	
1. Directory	
2. History	
3. Tool	
↓	Back    OK

STEP 2: Select **2. Search** by using Cursor Key, Digit Key (1) or Softkey.

1. REGIST	2: SEARCH
3. SETTING	4: DeleteAll
1:	2:    3:    4:

STEP 3: Select **MENU** to search.

TLBK1: SEARCH NAME	[A]
NUM    MENU	<

**Note:** *The display will show No TELBK Data if there are no entries to review.*

STEP 4: Select a search method from the following list.

[SEARCH MENU]			
NAME	GRP	NUM	MEM

Search Method	Description
1. Name	Search data from the name list registered in the directory.
2. Group	Display the lists registered to each group (01~20 groups).
3. Tel Number	Search data from the telephone number list registered in the directory.
4. Memory ID	Search data from the memory number registered in the directory.

STEP 5: The following is an example when NAME, GRP, NUM, and MEM are selected as a search.

NAME

TLBK1: SEARCH NAME [A]

NUM MENU < ← →

GRP

TLBK1: SEARCH GROUP

1: Group 01 2: Group 02

3: Group 03 4: Group 04

NUM

TLBK1: SEARCH NUMBER

MENU <

MEM

TLBK1: SEARCH MEMORY

MENU > [0-299]



## Make a Call From Directory

STEP 1: Display the detailed data for a target party (see [Find Registered Data](#)).

```
[SEARCH MENU]
NAME   GRP   NUM   MEM
```

The following display is an example of dial by name.

```
[1 ]   NEC
2132622000
   CHG   DEL.   Dial
```

STEP 2: Lift handset, press the **Speaker** key or press the **Dial** Softkey while displaying the detailed data for target party on LCD.

**Note:** *If multiple telephone numbers are assigned into a target party, a call is made to the first telephone number.*

## Delete All Directory Data

STEP 1: Display the main directory screen.

```
1: REGIST  2: SEARCH
3: SETTING 4: DeleteAll
   1:      2:      3:      4:
```

STEP 2: To delete all the registered data, press the **Enter** Key or **4**: Softkey to delete all the data. Below is a sample display of a deleted number.

```
TLBK1: DELETE ALL DATA
INPUT PWD: 4DIGIT
```

STEP 3: After 4-digit password is entered, display asks if you want to delete all the Directory data. To delete, press **Yes**.

STEP 4: After the appropriate Directory data is deleted, the display changes as follows:

```
DELETED ALL TELBOOK DATA
```

## Delete Specific Directory Data

STEP 1: Display the detailed data for a target party (see [Find Registered Data](#)).

STEP 2: Press **Menu** Key. The display changes as follows:

```
[SEARCH MENU]
Name  GRP  NUM  MEM
```

Select a search method to be deleted. Select one by using the Cursor key or Softkey. The example below displays a specific group deleted. Select Group 01.

```
1: NEC
2142622000
```

STEP 3: Select 1: NEC.

```
[1 ] NEC
2142622000
CHG  DEL.  Dial
```

STEP 4: Press the DEL Softkey to delete the appropriate Directory data.

STEP 5: After the appropriate Directory data is deleted, the following display appears:

```
TLBK1: DELETE DATA
DELETE DATA?
                Yes   No
```

STEP 6: The following confirmation message appears.

```
DELETE COMPLETE!
```

# 6. CALL HISTORY OPERATION

---

This chapter explains about the Call History function of DT Series. By using the Call History function, the user can make a call with a simple operation.

The Incoming Call History can register up to 50 records.  
The Outgoing Call History can register up to 10 records.

- [View Call History](#)
- [Make a Call From Call History](#)
- [Store Call History Data to Speed Dial](#)
- [Delete Call History Data](#)

## View Call History

STEP 1: Press **Menu** Key. The menu screen is displayed in the LCD.

STEP 2: Select **1. History** by using Cursor Key, Digit Key (1) or Softkey. (DT7XX menu shown)

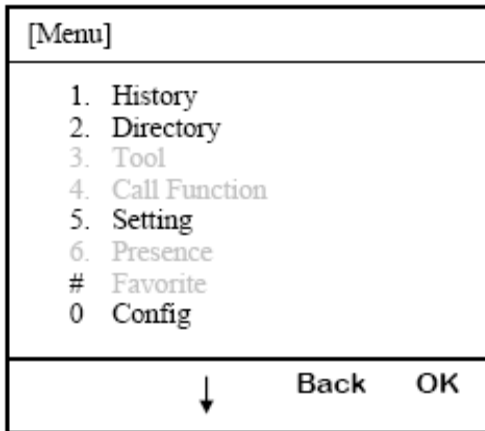

STEP 3: Select an item from the following histories, by using the Softkey.

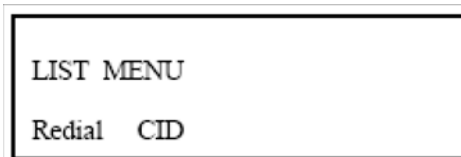

In this example, **1. CID** is selected.

STEP 4: The detailed information of the last call is displayed.



**Note:** Use the Cursor key to display the next/former records.

**Note:** If no history data is saved, "LIST END" will be displayed on LCD.

## Make a Call From Call History

STEP 1: Display the Call History data of the target telephone number referring to Make a Call from Call History. The following is an example when the history of Caller ID is displayed.

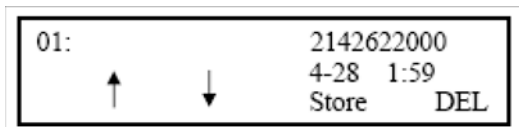

STEP 2: Lift the handset, press the **Speaker** key while displaying the call history information for the target telephone number on the LCD.

**Note:** *While the call history data is displayed, the user cannot make a call by dialing a telephone number.*

## Store Call History Data to Speed Dial

STEP 1: Display the Call History data of the target telephone number (see [Make a Call From Call History](#)). The following is an example when the history of a call is displayed.



STEP 2: Press the **Store Softkey** while displaying the call history information for the target telephone number. The display changes as follows:



STEP 3: Select **STA** to store in a Speed Dial bin or select **SPD** to store in a System Speed Dial bin. Select **TELBK** to store in a Telephone Book.

## Delete Call History Data

STEP 1: Press the **Menu** key. The menu screen is displayed in the LCD.

STEP 2: Select **1. Call History** by using the Cursor Key, Digit Key (1), or Softkey. (DT7XX menu shown)

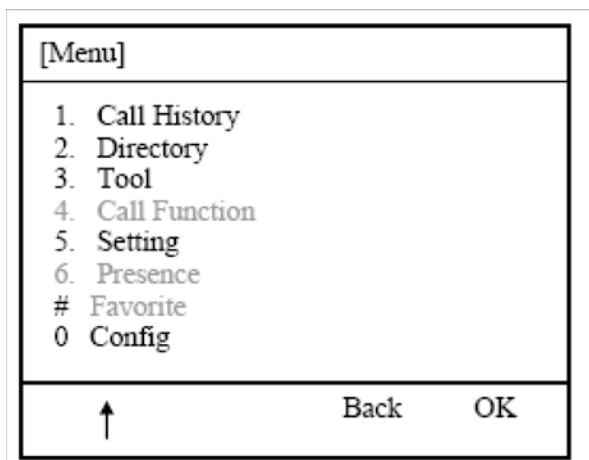

STEP 3: Select **CID** Softkey.

STEP 4: Select **DEL** Softkey.

STEP 5: Select **One** to delete a single call or **All** to delete all call history.



